

Compact Design, Small Capacity Fine Fog Nozzles with Spray Control Adaptor

CBIM

Features

- Compact design, fine fog spray nozzles with spray-control adaptor, which can regulate spray ON/OFF with a built-in piston.
- Available in liquid pressure or liquid siphon feed type, two spray pattern types (flat spray or full cone spray)—14 varieties in total. Wide selection.
- Capable of spraying smallest flow rate among all of our pneumatic spray nozzles.



Structure & Material

■ Mass: 125 g

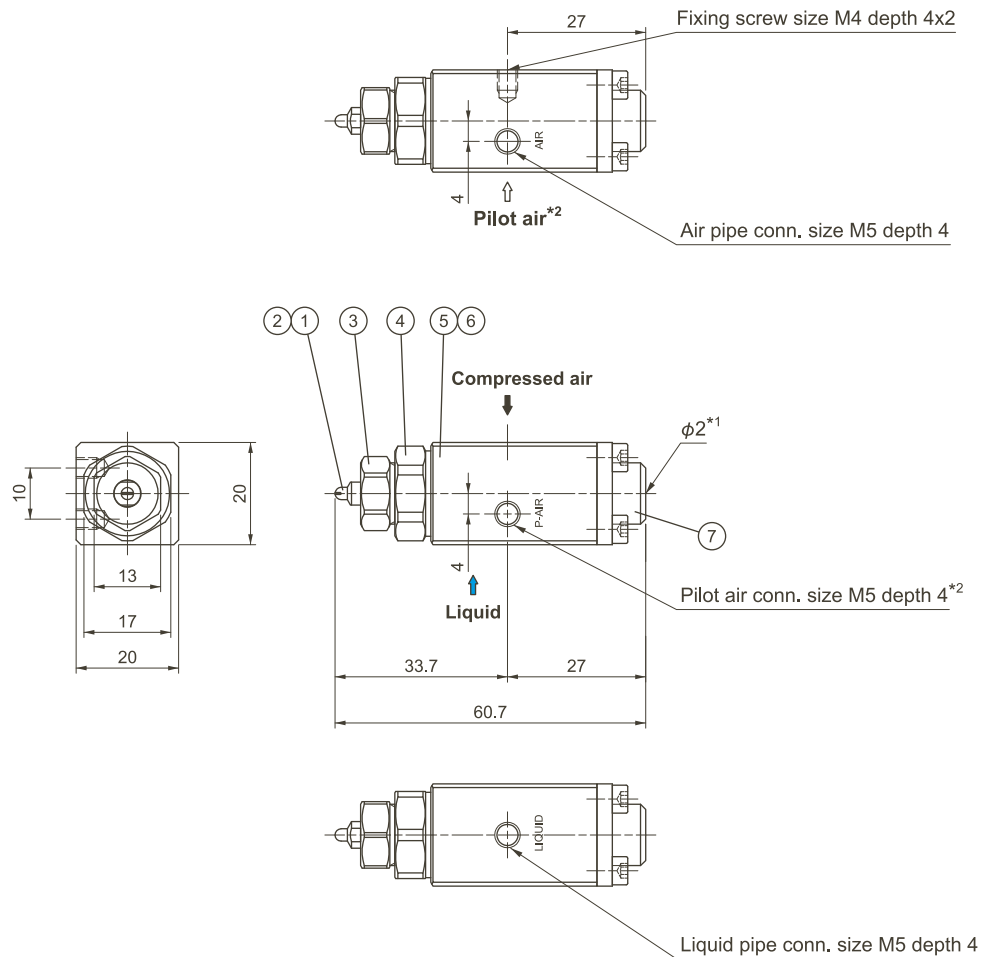

*1) Hole $\phi 2$ is for air relief.

*2) No pilot air for CSN-type adaptor.

■ Components and materials

No.	Components	Standard materials
①	Spray tip	S303
②	Core	S303
③	Cap	S303
④	Connector	S303
⑤	Adaptor	S303
⑥	Packing	FKM
⑦	Spring cap	S303

Compact Design, Small Capacity Fine Fog Nozzles

—Liquid Siphon Type—

CBIMV-S CBIMK-S

CBIMV-S (Flat Spray)

Features

- Flat spray pneumatic nozzle producing fine atomization with a mean droplet diameter of 30 μm or less.*1
- Liquid siphon feed type (liquid pressure device is not required).
- Spray angle of 80°.
- Even spray distribution across the entire spray area.

*1) Droplet diameter measured by laser Doppler method

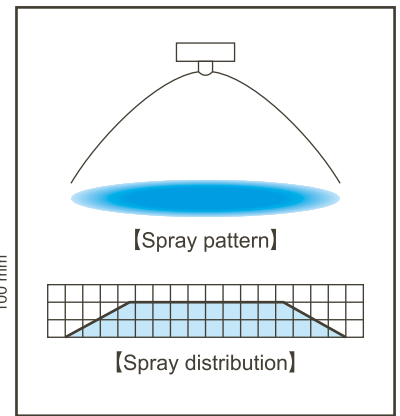
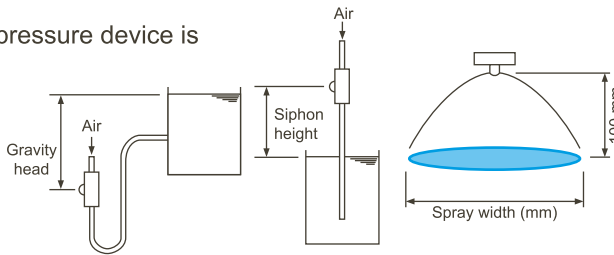

Spray angle code *2	Air consumption code	Air pressure (MPa)	Air consumption (ℓ/min, Normal)	Spray capacity (ℓ/hr)					Spray width*3 (mm)	Mean droplet diameter (μm) Laser Doppler method	Free passage dia. (mm)		
				Gravity head (mm)		Siphon height (mm)					Spray orifice	Adaptor	
				+300	+100	-100	-300	-500				Liquid	Air
80	005S	0.2	3.75	0.4	0.38	0.36	0.34	0.32	160	20-30	0.2	0.4	0.3
		0.3	5.0	0.29	0.27	0.25	0.23	0.21	165				
		0.4	6.25	0.16	0.15	0.13	0.11	0.1	170				
	01S	0.2	7.5	0.74	0.68	0.65	0.61	0.57	160	20-30	0.2	0.6	0.5
		0.3	10	0.55	0.52	0.5	0.47	0.43	165				
		0.4	12.5	0.38	0.34	0.3	0.27	0.25	170				
	02S	0.2	15	1.4	1.3	1.2	1.2	1.1	160	20-30	0.3	0.6	0.7
		0.3	20	1.1	1.0	1.0	0.9	0.9	165				
		0.4	25	0.7	0.7	0.6	0.6	0.5	170				
	04S	0.2	27	2.8	2.5	2.3	2.2	2.0	165	20-30	0.5	0.9	0.9
		0.3	36	2.4	2.1	2.0	1.9	1.8	170				
		0.4	46	1.9	1.7	1.6	1.5	1.4	175				
	075S	0.2	56	5.5	5.1	4.7	4.3	3.9	170	20-30	0.7	1.2	1.4
		0.3	74	4.7	4.3	4.0	3.7	3.3	180				
		0.4	92	3.5	3.2	2.9	2.7	2.5	190				

*2) Spray angle measured at compressed air pressure of 0.3 MPa and liquid siphon height of 100 mm. *3) Measured at 100 mm from nozzle and liquid siphon height of 100 mm.

CBIMK-S (Hollow Cone Spray)

Features

- Hollow cone spray pneumatic nozzle producing fine atomization with a mean droplet diameter of 30 μm or less.*1
- Liquid siphon feed type (liquid pressure device is not required).
- Spray angle of 60°.

*1) Droplet diameter measured by laser Doppler method

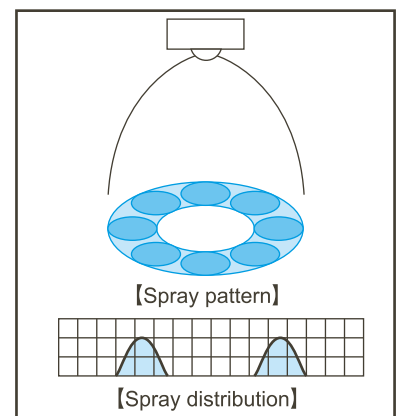
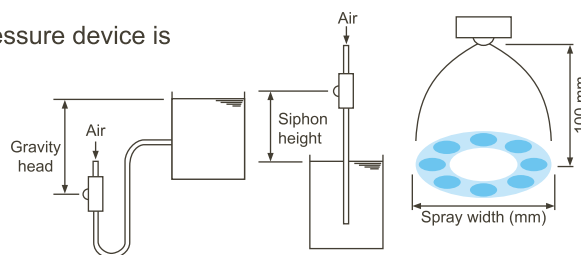

Spray angle code *2	Air consumption code	Air pressure (MPa)	Air consumption (ℓ/min, Normal)	Spray capacity (ℓ/hr)					Spray width*3 (mm)	Mean droplet diameter (μm) Laser Doppler method	Free passage dia. (mm)		
				Gravity head (mm)		Siphon height (mm)					Spray orifice	Adaptor	
				+300	+100	-100	-300	-500				Liquid	Air
60	04S	0.2	27	2.8	2.5	2.3	2.2	2.0	120	20-30	0.6	0.9	0.9
		0.3	36	2.4	2.1	2.0	1.9	1.8	120				
		0.4	46	1.9	1.7	1.6	1.5	1.4	120				
	075S	0.2	56	5.5	5.1	4.7	4.3	3.9	120	20-30	0.8	1.2	1.4
		0.3	74	4.7	4.3	4.0	3.7	3.3	120				
		0.4	92	3.5	3.2	2.9	2.7	2.5	120				

*2) Spray angle measured at compressed air pressure of 0.3 MPa and liquid siphon height of 100 mm. *3) Measured at 100 mm from nozzle and liquid siphon height of 100 mm.

How to order

Please inquire or order for a specific nozzle using this coding system.

<Example> CBIMV 11002 S303 + T S303

CBIMV	110	02	S303 + T S303
Nozzle series	Spray angle code	Air consumption code	
■ CBIMV, CBIMV-S			
■ CBIMK, CBIMK-S			
■ CBIMJ			

See the respective tables on pages 31-33 for Spray angle code and Air consumption code.

SCBIM series Spray Tip Interchangeability

			Liquid pressure type						Liquid siphon type	
			SCBIMV				SCBIMJ		SCBIMV-S	
			11001	80005	8001	45005	4501	20005	2001	80005S
Liquid pressure type	SCBIMV	11001	×	⊙	×	⊙	×	⊙	×	×
		80005	×	×	⊙	×	⊙	×	×	×
		8001	⊙	×	×	⊙	×	⊙	×	×
		45005	×	⊙	×	×	⊙	×	×	×
		4501	⊙	×	⊙	×	×	⊙	×	×
		SCBIMJ	20005	×	⊙	×	⊙	×	×	×
2001	⊙	×	⊙	×	⊙	×	×	×		
Liquid siphon type	SCBIMV-S	80005S	×	×	×	×	×	×	×	×
		8001S	×	×	×	×	×	×	×	×

Spray tips with ⊙ are interchangeable with each other.

CBIM series Cap Interchangeability

Adaptor type		T* ¹					CSP/CSN* ²		
		005	01	02	04	075	005	01	02
T* ¹	005	×	⊙	⊙	×	×	×	×	×
	01	⊙	⊙	⊙	×	×	×	×	×
	02	⊙	⊙	⊙	×	×	×	×	×
	04	×	×	×	⊙	⊙	×	×	×
	075	×	×	×	⊙	⊙	×	×	×
CSP/CSN* ²	005	×	×	×	×	×	⊙	⊙	
	01	×	×	×	×	×	⊙	⊙	
	02	×	×	×	×	×	⊙	⊙	

Caps with ⊙ are interchangeable with each other.

*1) Air consumption codes available for T-type adaptor are 005, 01, 02, 04, and 075.

*2) Air consumption codes available for CSP- and CSN-type adaptors are 005, 01, and 02 only.

When changing an adaptor type of the existing CBIM nozzle between T, CSP, and CSN types, it is possible to continue to use the same spray tips and core, which are the common parts (the cap is not).

Common applications

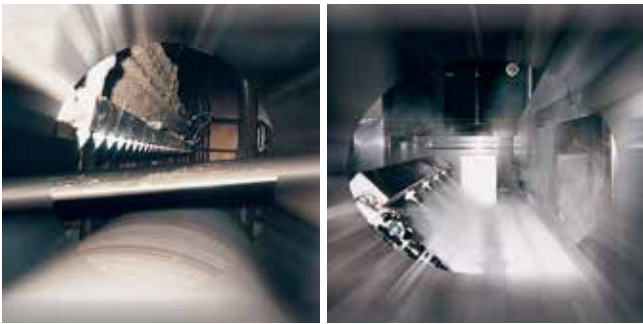

- **Paper & Pulp:** Moisture control, spraying mold lubricant, preventing cardboard from curling
- **Plastics:** Spraying anti-electrostatic agent, coating
- **Iron & Steel:** Cooling metal sheets
- **Glass:** Coating and cooling glass sheets
- **Textile:** Moisture control of textile and fiber
- **Printing:** Moisture control of paper after dryer of web offset printing machine
- **Automotives:** Cooling carriages of automobile bodies on the painting lines after oven
- **Food:** Spraying egg yolk, oil, honey, and more

New cleaning method "Fog Cleaning"

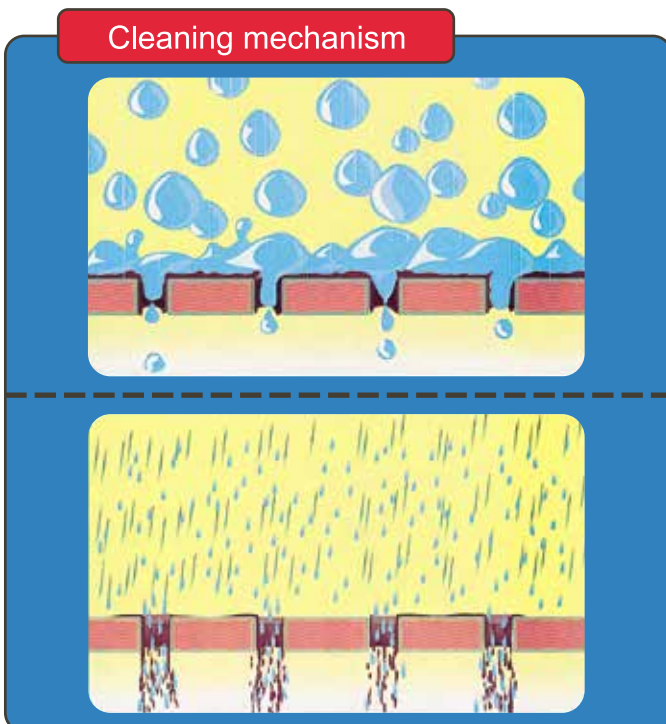

- For precise cleaning in cleaning process of photo-processing products

In conventional cleaning methods, large droplets created by hydraulic nozzles are used and cannot clean within fine interstices.

By using air, pneumatic spray nozzles produce very fine droplets for "fog cleaning".

■ Features of Fog Cleaning

- ① Very fine droplets get into interstices and wash out dirt.
- ② Velocity of cleaning water has been remarkably improved due to compressed air blow, that contributes to maximizing spray impact.
- ③ Compressed air will blow off puddles on surfaces of objects, stopping chemical reactions, and thus, it will get better cleaning effects.